

Triga E



kolor
w cenie

projekt: *Terma*

Podłączenia:

A=560-610:



A=900-1900:

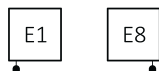

Wersja c.o. na stronie 232.

Polecamy:



Wieszak ZIP V



Grzałka ONE



Dane techniczne:

A ↕	B ↔	 [W]	D [mm]	E [mm]	F [mm]	 [dm ³]	 [kg]	Kod produktu	Kod konfiguracji s. 523
560	480	400	450	380	90	5,72	14,46	WLTRG056048	
560	680	600	650	380	90	8,01	20,30	WLTRG056068	
560	880	600	850	380	90	10,31	26,14	WLTRG056088	
560	1080	800	1050	380	90	12,60	31,99	WLTRG056108	
560	1280	1000	1250	380	90	14,90	37,83	WLTRG056128	
610	480	400	450	430	90	6,22	15,63	WLTRG061048	
610	680	600	650	430	90	8,71	21,94	WLTRG061068	
610	880	800	850	430	90	11,21	28,25	WLTRG061088	
610	1080	800	1050	430	90	13,70	34,56	WLTRG061108	
610	1280	1000	1250	430	90	16,19	40,87	WLTRG061128	
900	380	400	350	720	90	7,29	17,91	WLTRG090038	
900	480	600	450	720	90	9,11	22,42	WLTRG090048	
900	580	800	550	720	90	10,94	26,93	WLTRG090058	
900	680	800	650	720	90	12,76	31,45	WLTRG090068	
1300	380	600	350	1120	90	10,48	25,40	WLTRG130038	
1300	480	800	450	1120	90	13,10	31,79	WLTRG130048	
1300	580	1000	550	1120	90	15,72	38,18	WLTRG130058	
1300	680	1200	650	1120	90	18,34	44,56	WLTRG130068	
1700	380	800	350	1520	90	13,67	32,89	WLTRG170038	
1700	480	1000	450	1520	90	17,09	41,16	WLTRG170048	
1700	580	1200	550	1520	90	20,51	49,42	WLTRG170058	
1700	680	1500	650	1520	90	23,93	57,68	WLTRG170068	
1900	380	1000	350	1720	90	15,26	36,64	WLTRG190038	
1900	480	1200	450	1720	90	19,08	45,84	WLTRG190048	
1900	580	1500	550	1720	90	22,90	55,04	WLTRG190058	
1900	680	1500	650	1720	90	26,72	64,24	WLTRG190068	

Dostępność: na zamówienie.
Czas realizacji: do 10 dni roboczych.
Czas dostawy: 48 h od czasu realizacji
w dowolnie wskazane miejsce w Polsce.

Dostępne rozmiary:

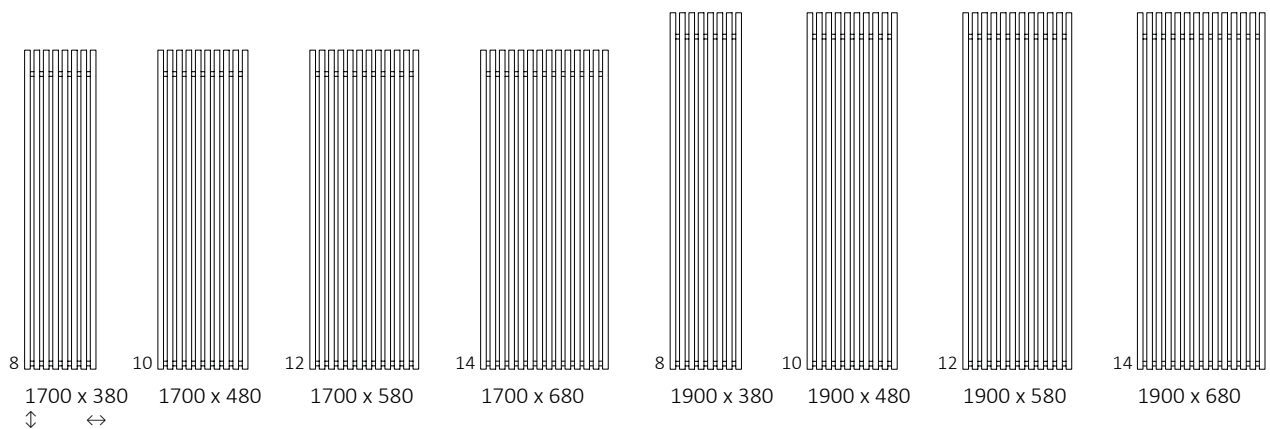
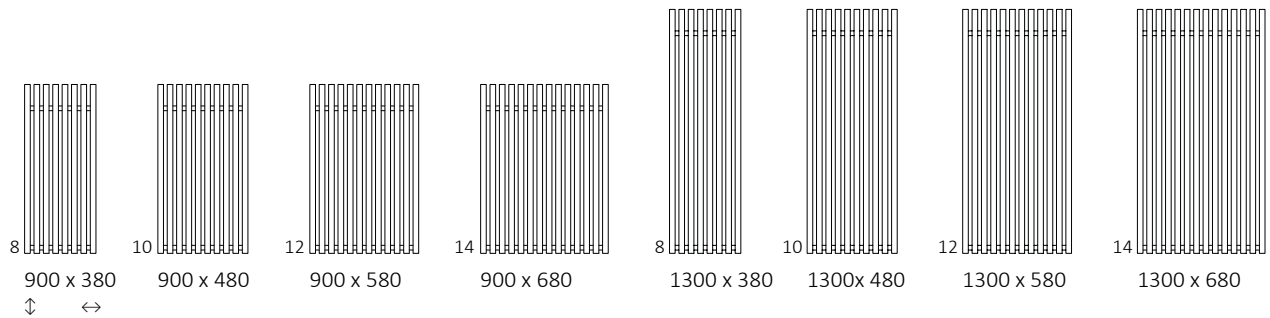
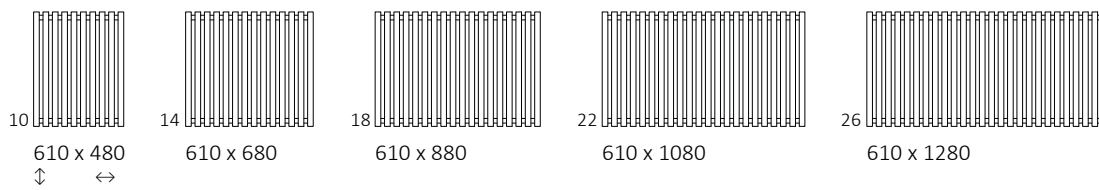
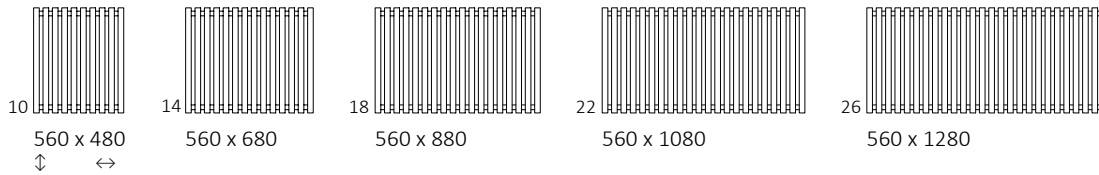

Triga E

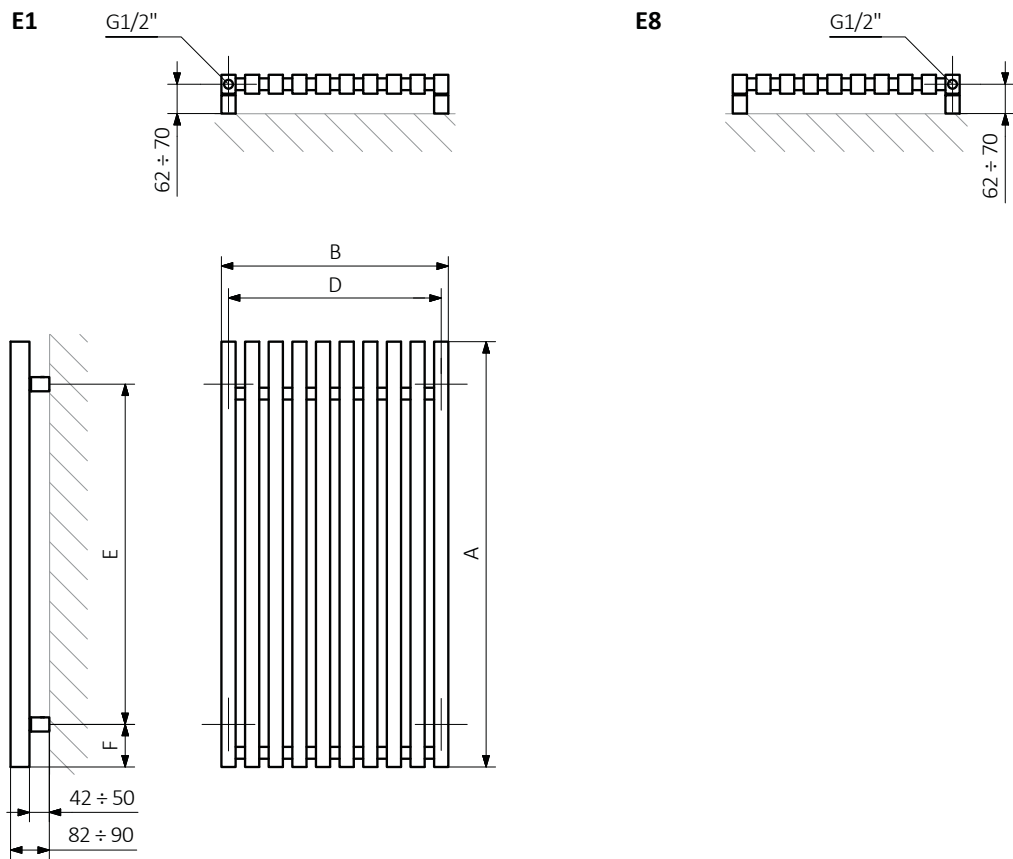

A – wysokość B – szerokość C1-C5 – rozstaw połączeń D – rozstaw konsol w poziomie E – rozstaw konsol w pionie,
 F – odległość od osi dolnej konsoli do dolnej krawędzi kolektora

Kolektor:

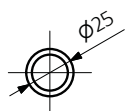

Profil:

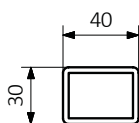

E2

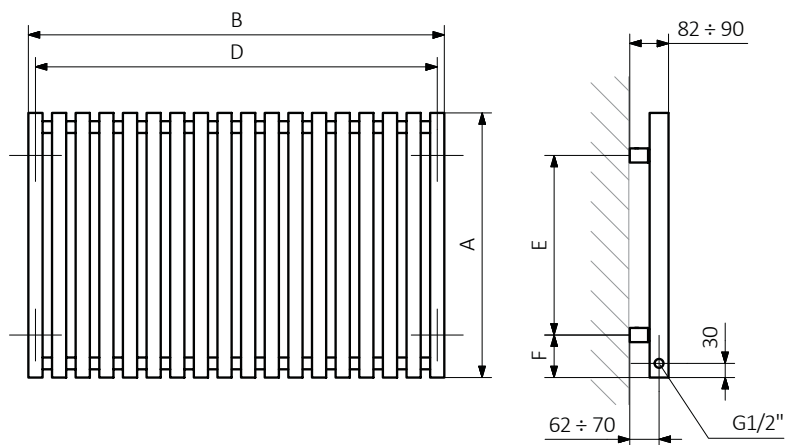

E7

