

Podłączenia:

A ↓ 440÷2000:

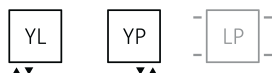

A ↓ 440÷640

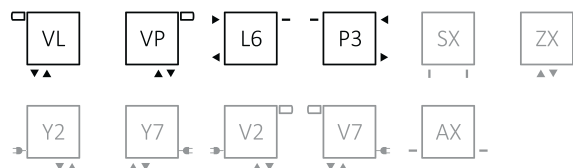

A ↓ 1800÷2000



Grzejniki elektryczne (A ↓ 440÷640), patrz: strona 387.



Polecamy:

Zestaw zintegrowany odcinający dla połączeń VL, VP





Zestaw maskujący zintegrowany



Dane techniczne:

Ciśnienie robocze: 0,8 MPa Maksymalna temperatura pracy: 95°C

A ↓	B ↔	C1 [mm]	C2 [mm]	C3 [mm]	C4 [mm]	75/65/20°C [W]	55/45/20°C [W]	 [W]	D [mm]	E [mm]	F [mm]	 [dm³]	 [kg]	Kod produktu	Kod konfiguracji s. 521
440	820	50	-	400	-	705	370	800	710	400	21	6,41	13,76	WGDLF044082	
440	1020	50	-	400	-	885	465	800	910	400	21	8,01	17,15	WGDLF044102	
440	1220	50	-	400	-	1061	556	1000	1110	400	21	9,60	20,54	WGDLF044122	
540	820	50	-	500	-	846	442	800	710	500	21	7,61	16,32	WGDLF054082	
540	1020	50	-	500	-	1057	552	1000	910	500	21	9,50	20,35	WGDLF054102	
540	1220	50	-	500	-	1264	661	1200	1110	500	21	11,39	24,38	WGDLF054122	
640	820	50	-	600	-	986	514	1000	710	600	21	8,80	18,89	WGDLF064082	
640	1020	50	-	600	-	1233	644	1200	910	600	21	10,99	23,55	WGDLF064102	
640	1220	50	-	600	-	1458	760	1500	1110	600	21	13,19	28,22	WGDLF064122	
1800	500	50	460	-	500	1403	717	-	390	1760	21	13,61	29,25	WGDLF180050	
1800	580	50	540	-	580	1623	830	-	470	1760	21	15,87	34,09	WGDLF180058	
2000	500	50	460	-	500	1556	802	-	390	1960	21	15,04	32,32	WGDLF200050	
2000	580	50	540	-	580	1774	909	-	470	1960	21	17,55	37,67	WGDLF200058	

Dostępność: na zamówienie.
Czas realizacji: do 10 dni roboczych.
Czas dostawy: 48 h od czasu realizacji
w dowolnie wskazane miejsce w Polsce.

Dostępne rozmiary:

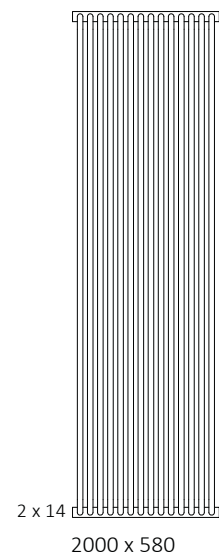
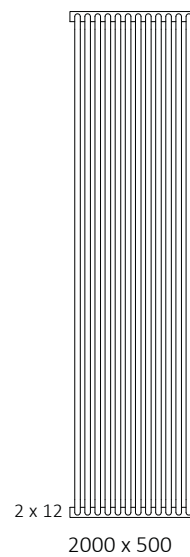
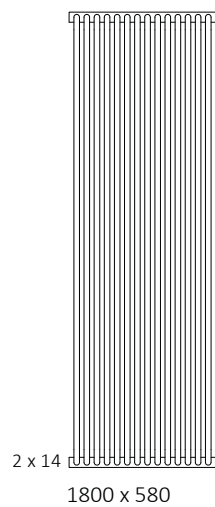
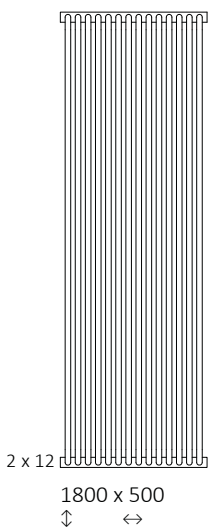
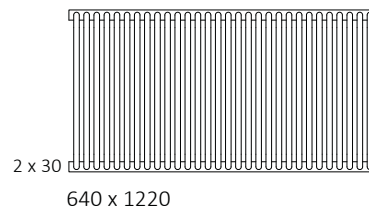
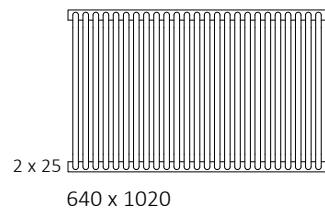
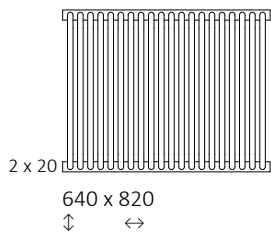
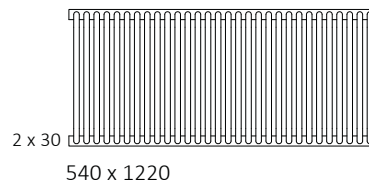
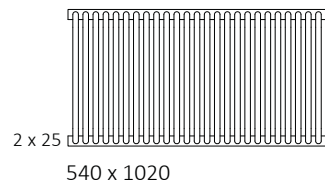
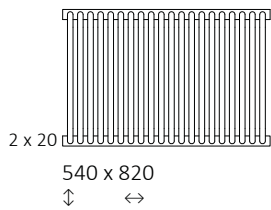
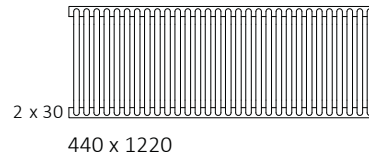
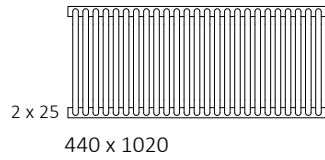
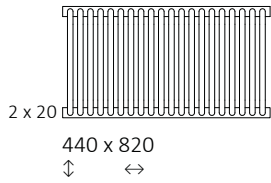

Delfin

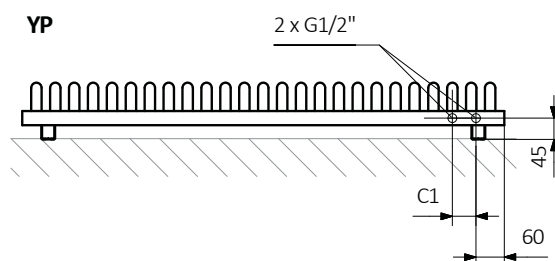
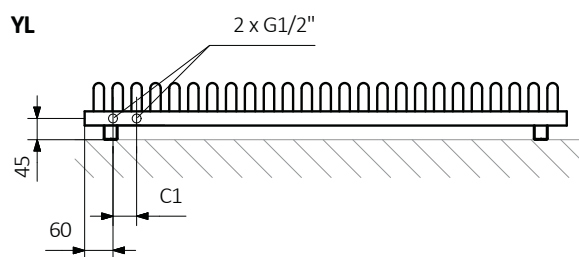
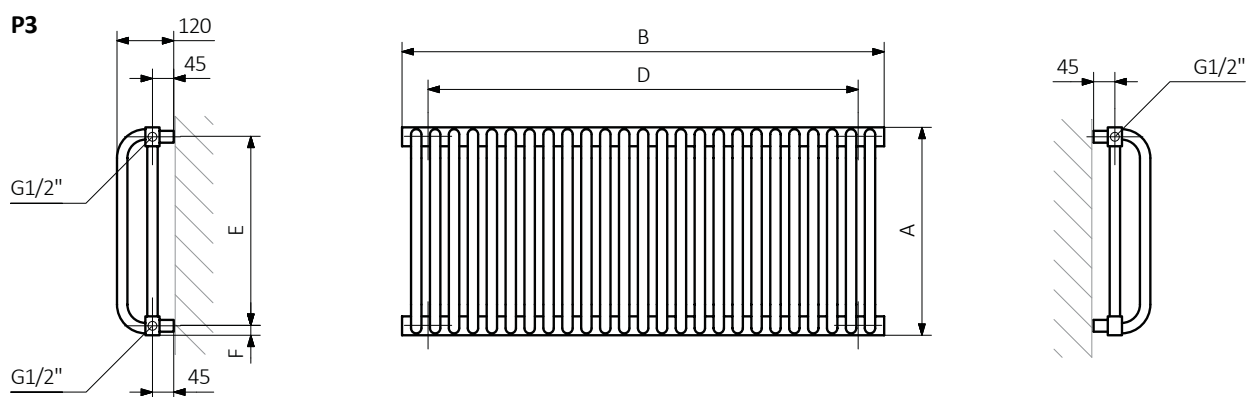
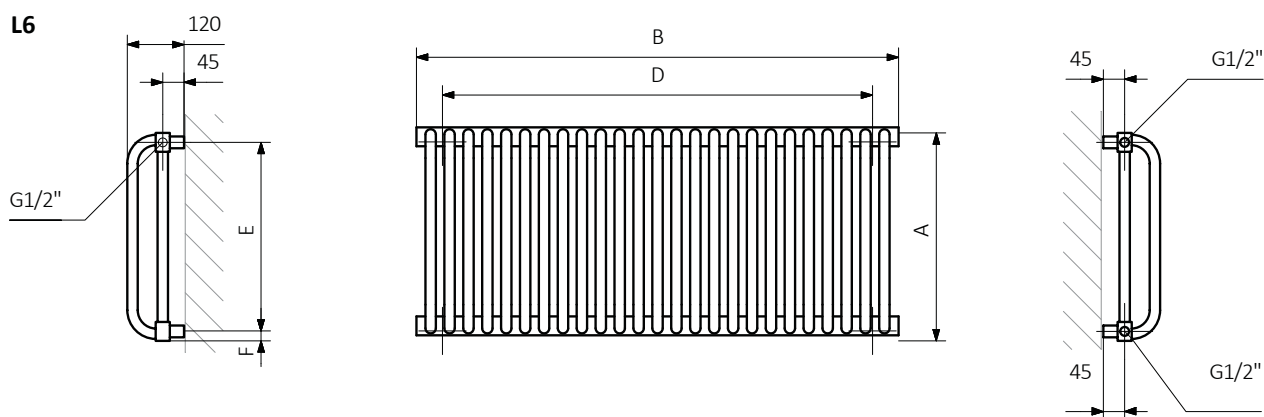

A – wysokość B – szerokość C1-C5 – rozstaw podłączeń D – rozstaw konsol w poziomie E – rozstaw konsol w pionie, F – odległość od osi dolnej konsoli do dolnej krawędzi kolektora

Kolektor:

Profil:

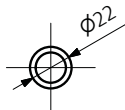
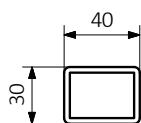

VL

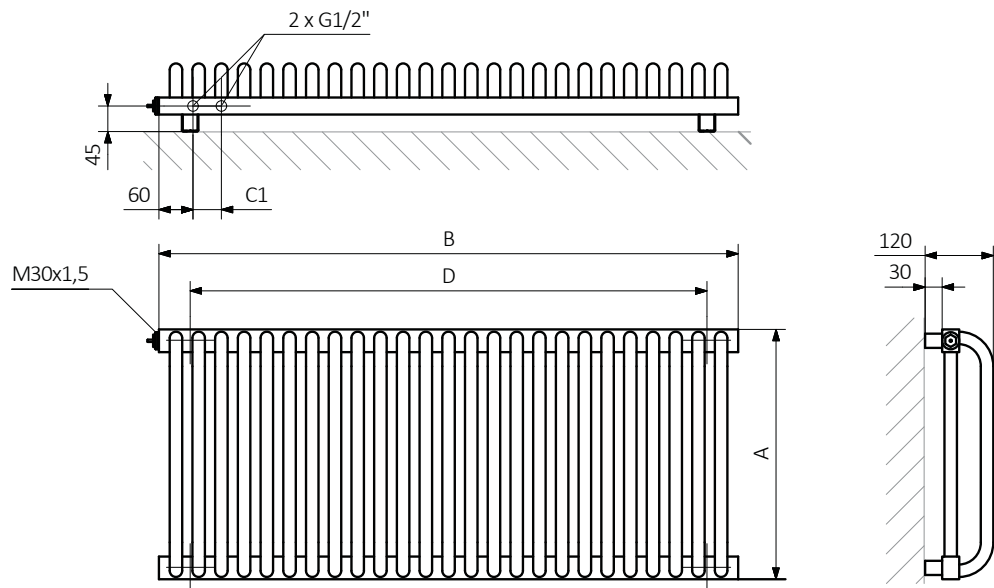

VP

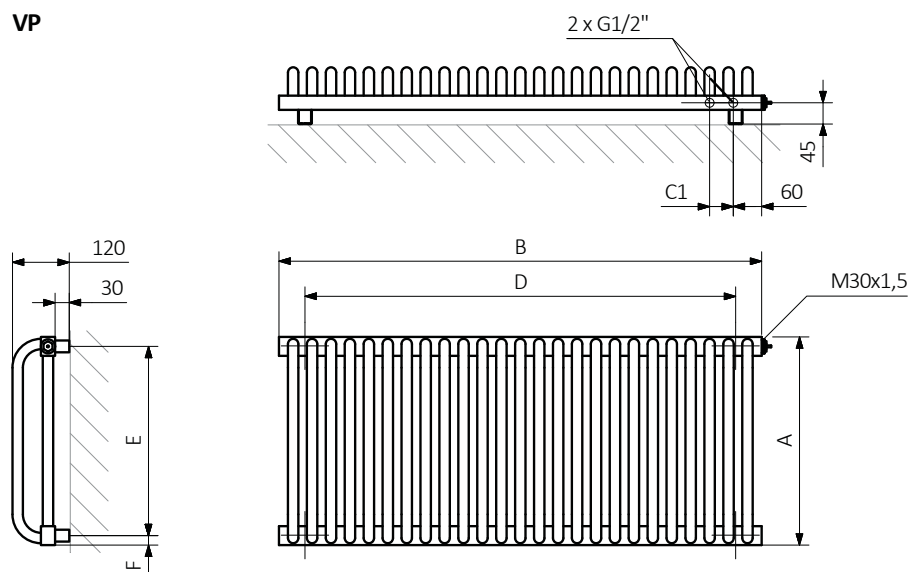

Delfin

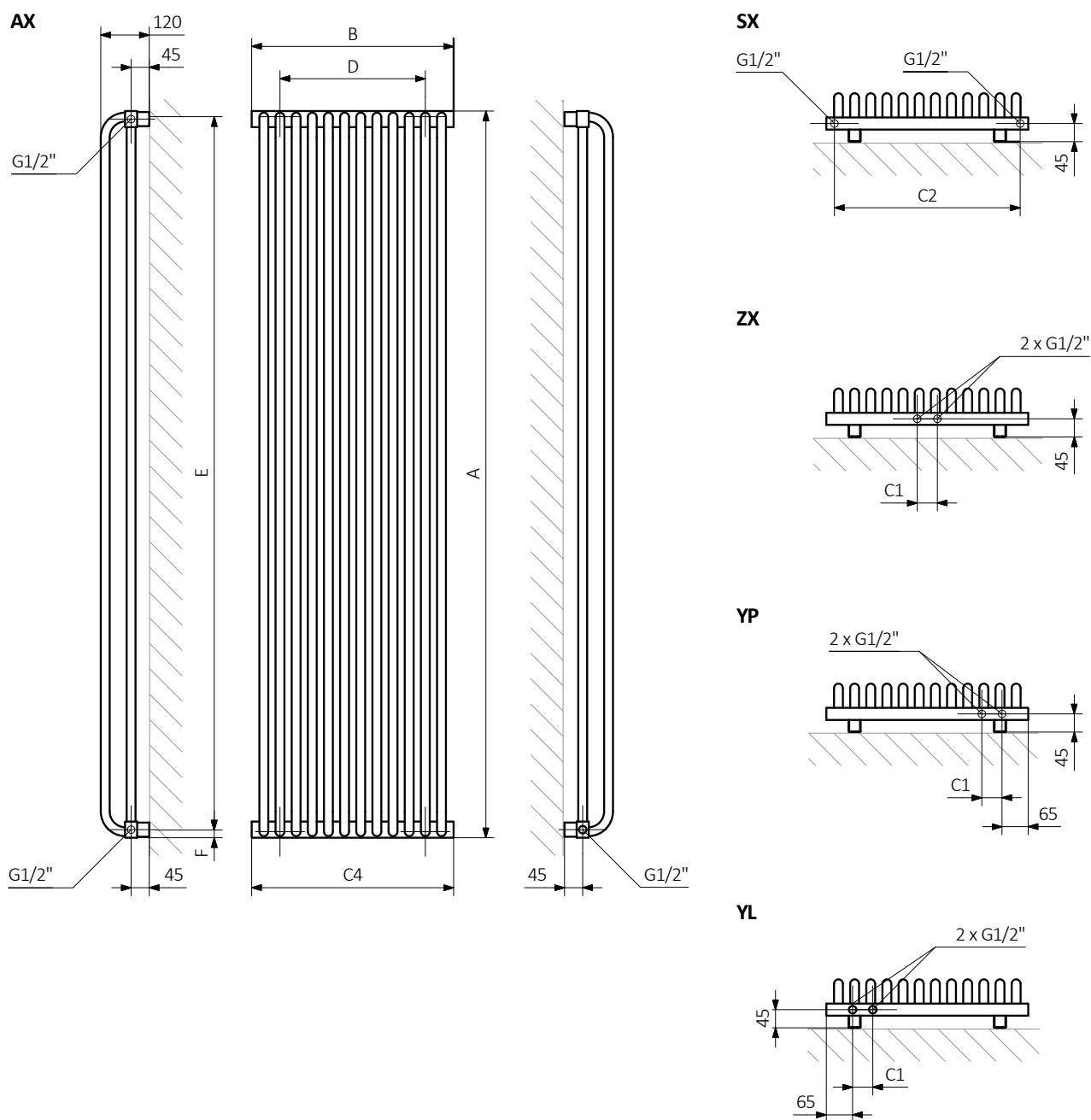

A – wysokość B – szerokość C1-C5 – rozstaw podłączeń D – rozstaw konsol w poziomie E – rozstaw konsol w pioniu, F – odległość od osi dolnej konsoli do dolnej krawędzi kolektora

Kolektor:

Profil:

